

Command Station Operation Manual Addendum

For Software Version 1.31

Check out all the great new features in this latest software release.

Contents

- Page 2 - Beats Mode
- Page 14 Paste Repeat
- Page 15 Erase Track
- Page 16 Erase All Controllers
- Page 16 Rechannelize Input
- Page 17 External Song Start On/Off
- Page 18 New Destination for Programmable Knobs & Triggers
- Page 18 New Sequencer Features
- Page 19 Local Control Change Receive
- Page 19 Tick 0 is now Visible for External Tracks
- Page 20 Connection Examples
- Page 23 Block Diagrams

Other Changes in version 1.31

- The sequencer engine has been optimized for speed and stability. Pattern changes now occur in less than 3 mS.
- Many improvements to MIDI start/stop/continue/SPP. You can now use these functions for punching into record from record-pause mode.
- Expanded Continuous Controller Range The programmable knobs, thin, erase and list edit now support continuous controllers 01-119. Formerly the range of continuous controllers was from 01-95.
- Tracks now default to “int” instead of “both.”
- If there is no XL-7, MP-7, or Proteus 2500 ROM in the machine, the metronome will use preset 126 in user bank 3. Key 60 = accent; Key 61 = tick.
- Realtime record automatically takes you to the realtime record screen, and entering the song or pattern edit menus automatically punches out of realtime recording.
- When saving a Preset, Song or Pattern, the save location is automatically selected as the current Preset, Song or Pattern. This prevents confusion and makes the instrument even easier to use.

Beats

Beats mode is a 16-track play-only sequencer optimized for live performance and groove creation. Beats mode allows you to trigger, latch and unlatch synced loops and grooves from separate keys on your keyboard. Simply select a bts: preset and play the 16 trigger keys to bring specific *Parts* in and out. Any preset can be selected and used by assigning a BTS riff in the Preset Edit menu.

Here's how it works.

1. **Select a bts: preset, ...or assign a BTS riff** to one of the percussion presets in the Preset Edit Menu. KIT riffs may also have several tracks.
2. Set the "Trigger Buttons Function" in the Controllers menu to **Play Beats Parts**.
3. **Select Triggers** in the Command Functions section.
4. Each of the Beats Parts is assigned to a trigger key. Bring each part in or out by pressing that key. Keys can also be Latched (*press the key once to turn the part on, press it again to turn the part off*). Other control keys allow you to Mute All Parts, Clear All Parts, and Start & Stop the beat. For BTS Riffs the 16 parts are arranged in the following manner:

Main Groove	Alt. Groove	Perc / Fills	Instr/Wild
1. Kick1	5. Kick2	9. Perc3/Fill1	13. Inst1/Wild1
2. Snare1	6. Snare2	10. Perc4/Fill2	14. Inst2/Wild2
3. Hihat1	7. Hihat2	11. Perc5/Fill3	15. Inst3/Wild3
4. Perc1	8. Perc2	12. Perc6/Inst.	16. Bass

For each Beats Riff, you have 2 Grooves, 4 Fills which correspond to the four parts of the Main and Alternate groove, and 4 Instrument parts. By adding and removing parts, you control the complexity of the groove.

Each part can also be scaled by *Key Velocity*, allowing you to fade parts in and out (if velocity is routed to volume) as you play, or can be *Transposed* over a six octave range. Each part can be assigned to any one of four *Groups*, which allow multiple parts to be triggered from a single key. You can only access Groups using the keyboard trigger keys. See the Factory Setup diagram on the next page.

The factory **BTS** riffs range from 4-16 bars long, using 4 to 16 tracks each. Normally you'll use the Command Function buttons to bring parts in and out. Beat Parts can also be assigned to groups so that multiple parts can be triggered from a single key press. The Group Triggers, Clear Parts, Trigger Hold and Mute keys are only accessible via MIDI or the keypads.

Trigger layouts are saved with the Multisetup. The Factory Multisetup (63) has all the Beats controls assigned to the keyboard as shown in the diagram on the following page. These MIDI note numbers have been placed below the lowest key on the keyboard so as not to interfere with normal playing. Setting the Beats Keys Offset function (*page 10*) to +48 will allow you to access these hidden control keys.



Beats (bts:) Riffs are special 16-part riffs made especially for use with Beats mode. KIT riffs may have four or five parts.

Other riffs usually have only one part recorded.



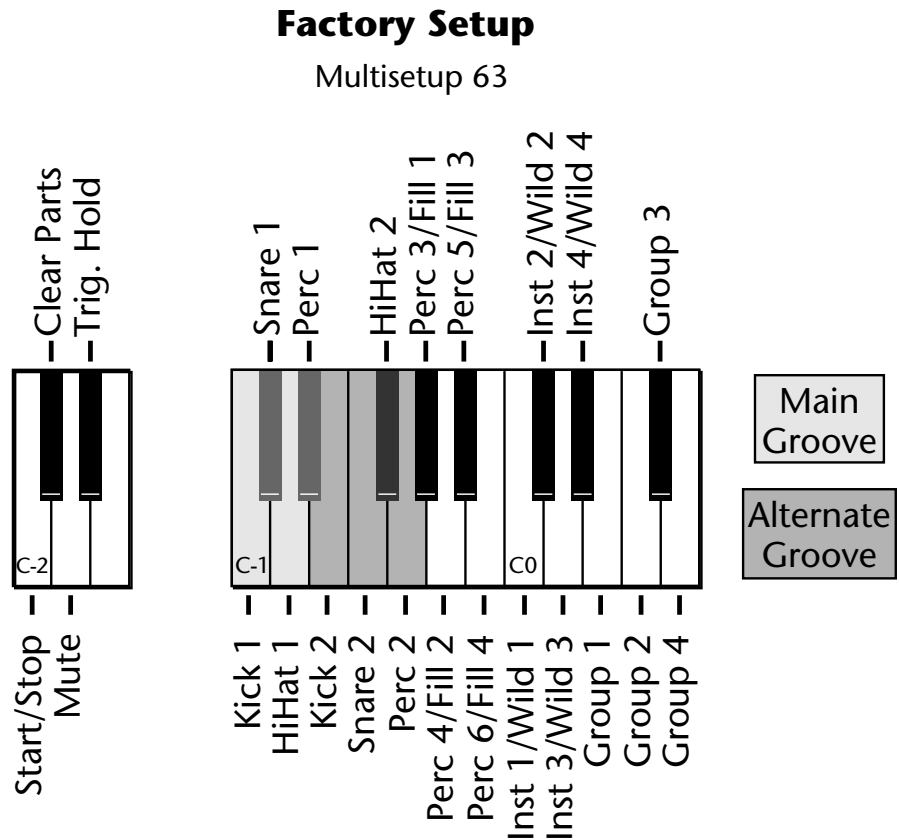

By assigning Trigger Buttons to the keyboard Beats Layout Keys, you can trigger Beats and MIDI notes using the Trigger buttons.

 By assigning Trigger Buttons to the keyboard Beats layout keys shown at right, you can trigger Beats and MIDI notes using the Trigger buttons.



The chart above shows the Factory Multisetup assignment of each Part, the 4 Groups and the Control Keys. These assignments can be modified to suit your personal preference, then saved in one of the Multisetup locations.

 Starting Beats mode with the Start/Stop key allows you to start the sequencer rolling silently. Then you can bring Parts in and out using the "Busy" control.

 If Mute is set to 1-bar, the Part mutes for 1 bar then un-mutes.

- **Start/Stop Trigger** Starts the beat sequencer from the beginning of the sequence. When latched, pressing once starts and pressing again stops. When unlatched, the sequence runs as long as the key is held. Once the Beats sequencer is started, it continues to run even if no triggers are active. Start/Stop doesn't clear latched parts when it stops the sequencer. Any trigger played after stopping will not only start the sequencer and play that trigger's part, but also play all previously latched parts.
- **Clear Parts** Clears any enabled parts. This control provides a quick and easy way to shut off all latched Parts. Latch mode has no effect on this key.
- **Mute** Mutes all Parts while held, but the Beats sequencer continues running.
- **Trig Hold** When this key is held, all other Trigger Keys behave as if they were in Latch mode.

Beats Mode

The Beats sequencer plays as long as any Beats triggers are active. Beats Riffs can also be **Restarted** using a MIDI Song Start command even if the Beats channel is not currently selected. The Audition LED illuminates whenever the Beats sequencer is running (even if no Parts are playing).

Pressing the Audition button or starting a Demo causes the Beats sequencer to stop. Pressing the Audition button plays selected Parts on "bts:" presets.

All Arp/Beats parameters are saved with the Multisetup.

This screen turns Beats mode on and has several other features which allow flexible control over Beats mode. There are several status modes that determine when Beats will be turned on and which Riff will be used.

Beats and BEAT Triggers can be set to different MIDI channels. This allows you to perform on two MIDI channels at once with a keyboard that only transmits on a single MIDI channel.

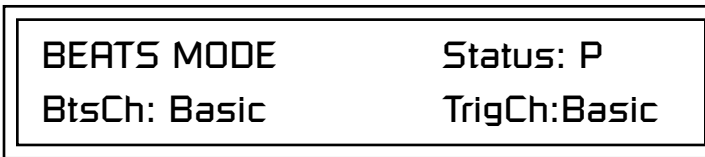

 The Basic Channel is the MIDI channel currently displayed in the Main Screen.

Status

- **Off** Beats mode off.
- **On** Beats mode on. The Riff assigned in the preset is used.
- **P** Beats mode is turned on *ONLY* if the Riff assigned in the preset is a "bts:" riff. The Riff assigned in the preset is used. (*Default setting*)
- **M** Beats mode on. The Master Riff is used (Arp/Beats menu).

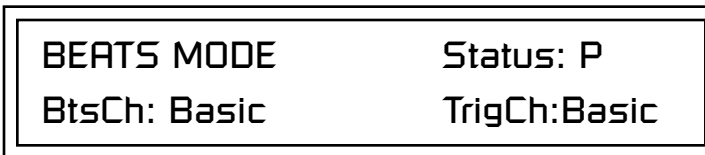

Beats Channel (BtsCh)

- **01-16** Selects the MIDI channel on which Beats play.
- **Basic** Beats play on the MIDI channel displayed in the Main Screen.

Trigger Channel (TrigCh)

- **01-16** Selects the MIDI channel on which Trigger Keys will be active.
- **Basic** Sets the Trigger Keys to the MIDI channel displayed on the Main Screen.



The TRIGGER BUTTONS FUNCTION is a new screen which changes the 16 trigger buttons into “Beats Part Mute” buttons.



If you don’t select a “bts:” preset, only the first trigger key will work.

Riffs marked “BTS” have 16 parts. Riffs without “BTS” usually have only 1 part.

- You can create your own Beats presets by assigning a BTS riff in the Preset Edit menu.

► Beats Setup:

Set the Trigger Buttons to Beats Mode

1. Press the **Controllers** button on the front panel.
2. Turn the **data entry control** clockwise until you find the “TRIGGER BUTTONS FUNCTION” screen.
3. Set the lower line of the display to read, “Play Beats Parts”.
4. Press the **Controllers** button on the front panel again to exit the menu.

Set the Trigger Buttons to be Triggers

5. Press the **Triggers** button in the Command Functions section of the front panel. OK, now you’re ready to start playing Beats.

► Playing Beats:

Selecting Beats Presets

1. Press the **right cursor button** twice so that the cursor is located beneath the **Category** field.

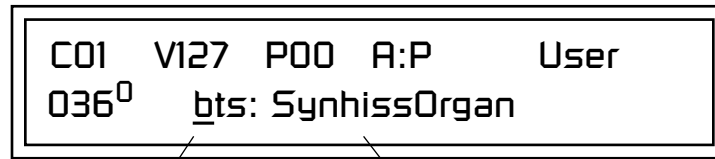

2. Turn the **data entry control** until **bts:** is shown in the Category field.
3. Press the **right cursor button** so that the cursor is underneath the **Preset Name** field.
4. Now turning the **data entry control** selects ONLY **bts:** presets!

Play Beats

5. Press any of the sixteen front panel **Trigger Buttons**. Notice that each button brings in a specific part. The chart below shows which buttons control which part in **bts:** presets.

Main Groove	Alt. Groove	Perc / Fills	Instr/Wild
1. Kick1	5. Kick2	9. Perc3/Fill1	13. Inst1/Wild1
2. Snare1	6. Snare2	10. Perc4/Fill2	14. Inst2/Wild2
3. Hihat1	7. Hihat2	11. Perc5/Fill3	15. Inst3/Wild3
4. Perc1	8. Perc2	12. Perc6/Inst.	16. Bass

6. Also notice that the Audition LED comes on when Beats begin playing. Beats are simply multitrack Audition Riffs. You can use the **Audition** button to turn Beats on and off.
7. Try out a few different **bts:** presets.

Get Busy!

The Controller knobs can be programmed to control Beats. Check it out!

8. Scroll to the **Preset PatchCords** screen in the **Preset Edit** menu. The screen below appears.



9. Move the cursor under the Cord destination and change it to **BtsVari**. Exit the Preset Edit menu.
10. Turn controller **Knob 15 /O** with a Beats Riff playing. This knob now controls the *Beats Variation* parameter. Beats Variation changes which parts are playing without changing the number of parts. This makes it easy to try out different combinations of Beat Parts.
11. Try hooking controller knobs up to other Beats controls such as Beats Busy. See “Beats Controllers” on page 7 for more information.

► **To Play Beats on a different MIDI channel:**

Beats can be assigned to a certain MIDI channel while you play the keyboard on another channel. *(Make sure you have Beats mode set up correctly as described in “Beats Setup” on page 5.)*

1. Press the **Arp** button and turn the data entry control until the screen shown below appears.

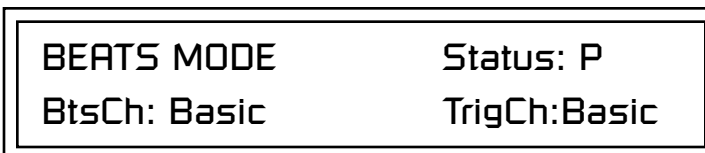

2. Set the Beats Channel (BtsCh) to **01**.
3. Select any **bts:** preset on channel 1 (*main screen*).
4. Press any of the sixteen **Beats buttons** to start your Beat playing. *(Do NOT start Beats by pressing the Audition button.)*
5. Press the + **Channel** button to the left of the LCD to select **channel 2**.
6. Select a preset to jam along with the Beat.
7. The Trigger Keys now play Beats and the other keys play the preset on channel 2.
8. The Audition button can be used to turn the Beat off. *(If you try to use it to turn Beats on while on channel 2, the Riff on channel 2 will play.)*

 **Wrong FX?** In *Omni mode*, the FX assigned to channel 2 will be used. In *Multi mode*, the Master FX settings will be used.

Beats Controllers

Beats can be controlled using the front panel real-time controllers or external MIDI continuous controllers. **Controllers are patched to Beats via the Preset PatchCords located in the Edit menu.** The following Preset PatchCord destinations control Beats.

Beat Velocity Group 1-4 (BtsVelG1 -> BtsVelG4)

Parts assigned to one of the four Beats groups can have their velocity scaled by the controller input. Since most “bts” presets have velocity controlling volume, this control can be used to mix the relative levels of the Groups.

Beats velocity works as a percent *addition*. An input value of 0 (or no Cord) means change the velocity by 0%. A full scale modulation setting of 100% in the PatchCord adds 100% to the velocity value $100\% + 100\% = 200\%$. A PatchCord setting of -100% *subtracts* 100% from the velocity (making it 0). Beat velocity scalings are reset with a preset change.

Beat Xpose Group 1-4 (BtsXpsG1 -> BtsXpsG4)

Parts assigned to one of the four Beats groups are transposed by the controller input. Transpose works by shifting the keyboard position and not by changing the tuning of individual notes. Therefore, on a Beats presets (bts), where different instruments are assigned to each key, Transpose has the effect of changing the instrument used by a particular part. This control ADDS to the Part Transpose set in the Beats Transpose screen (page 11). Beat transpose offsets are reset with a preset change.

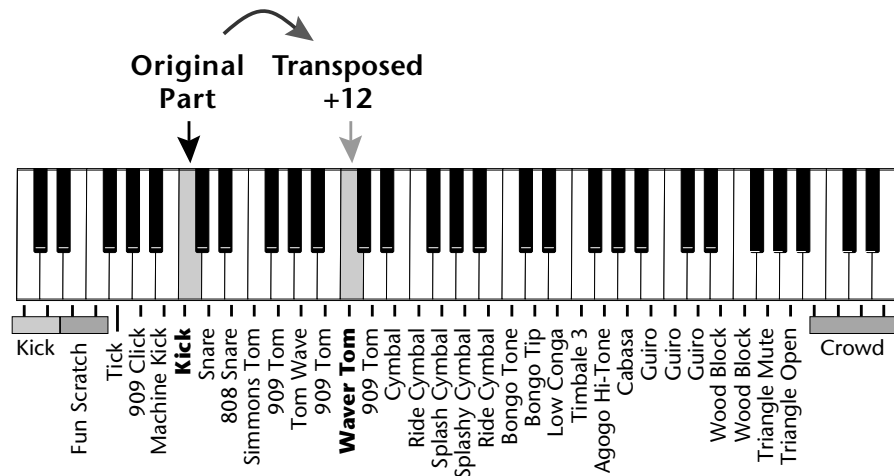



Beat Busy (BtsBusy)

This destination determines which parts are enabled. Beat Busy will accept either positive or negative values.

- **Positive values Add parts to whatever parts are triggered**
- **Negative values Remove parts that are triggered.**

 A PatchCord amount of 50% is enough to drive Beat Busy to the maximum setting.

 **Hot Tip!**
Bidirectional Mod Knob:
Set Controller M to BtsBusy with a Cord amount of +100, then add a DC bias to BtsBusy with a Cord amount of -50. The controller knob now adds or subtracts "Busyness".

 **Cool Tip!** Connecting Key Pressure to Beat Busy at 50% increases BEAT complexity the harder you press.

Suppose the pitch wheel (which can output both positive and negative values) were connected to Beat Busy and four Key Triggers are down. As the pitch wheel is moved from center to fully up, the remaining parts will be enabled until the pitch wheel is fully up and all parts are playing. Moving the pitch wheel from center to fully down, the four triggered parts are sequentially removed until at the most negative position of the wheel, no parts are playing.

The Busy control acts on the Beats condition whenever the control is changed. Playing more triggers without changing the Busy control simply adds them until the Busy control is changed again, at which point it will possibly add or subtract parts as needed.

The interaction between the Busy control, Triggers, Part Velocity and Group Velocity can get complicated, but works according to this rule:

WHICHEVER CONTROL WAS LAST CHANGED TAKES OVER

When interacting with the Group Velocity scale control, the Busy control ignores group velocity even when it is set to zero, enabling and disabling parts as necessary. If the Group Velocity is changed *after* the Busy control, it takes control, scaling parts as it deems necessary.

The Busy control *does* take the Part velocity into account when adding and subtracting parts. If a part has a velocity of 0%, it is removed from the list of parts that the Busy control adds or subtracts. Therefore, you can use the Part Velocity control to remove parts you don't want to hear.

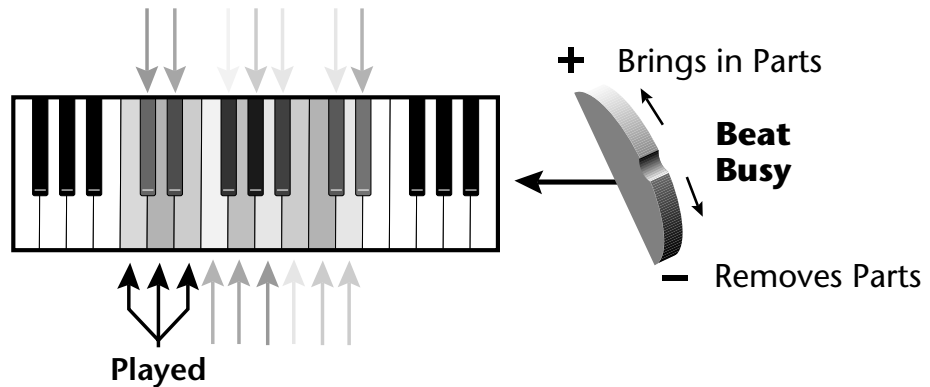

Positive controller values bring in new Parts and negative controller values remove Parts that are latched or held. In this example, the Pitch Wheel is connected to Beat Busy since it outputs negative as well as positive values.

Beat Variation (BtsVari)

Beat Variation varies which Parts are brought in and out using the Beat Busy control. Increasing this control mixes up the order in which Parts are brought in and out, thus providing even more permutations to the Beat.

Beats Keys/Trigger Layout



Save your Beats Keys Layouts and all other Arp/Beats parameters using "Save Setup" function in the Global menu.

This screen assigns the 16 Beats Triggers to keyboard notes on the Beats channel. For each Part, Group and Control Key you can select the following options:

- **Key** Selects which keyboard key triggers the Part
- **Latch** The first key press turns the Part on, the next turns it off.
- **Unlatch** The Part plays only while the key is held.
- **1-bar** The Part plays for one bar then stops.

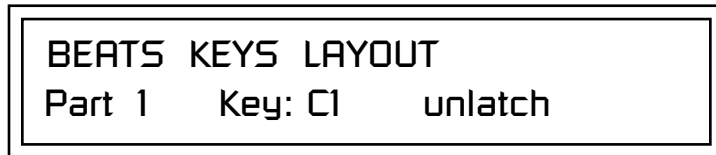

1-Bar Trigger Option

The 1-bar option requires a bit of explanation. When a trigger key is pressed before the last beat of the measure, the part will continue playing until the end of the measure. If the Trigger Key is pressed after the last beat of the measure, the part waits until the next measure before playing. Then it plays for the entire measure and stops. The time signature and the measure bounds are determined by the particular Beats Riff you are playing.

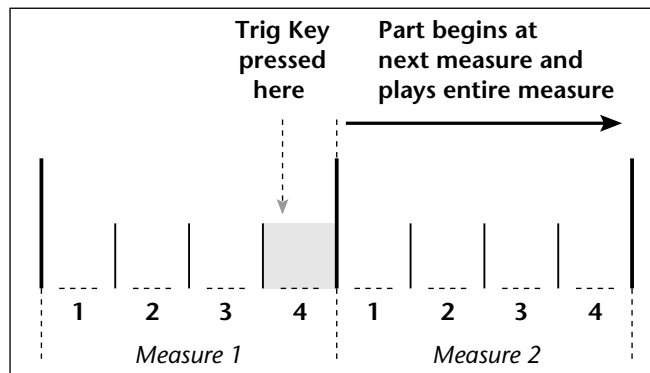
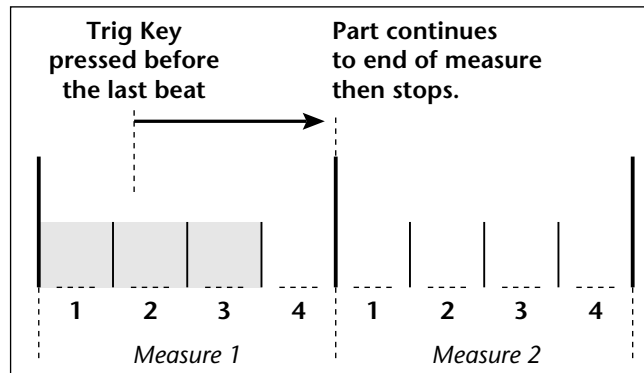

Beats Keys Offset

This function slides the Beats Trigger keys (*assigned in the previous screen*) up and down the keyboard. This makes it easy to change the keyboard location of the trigger keys without having to re-assign each key. A positive offset moves the group of triggers up the keyboard by the designated number of keys. Negative offsets move the trigger group lower on the keyboard.

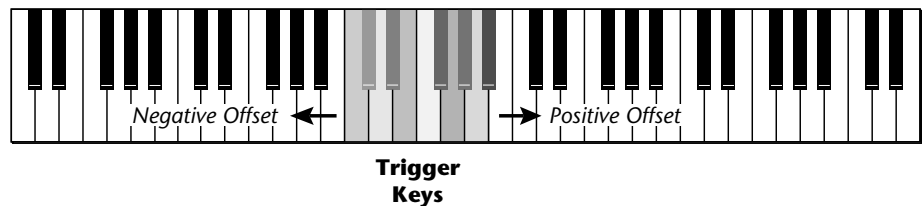

Beats Keys Offset slides the entire group of beats triggers up or down the keyboard.

Beats Part Velocity

Each note of a Beats Riff can have its recorded velocity scaled by a value (from 0 to 120%) of the recorded velocity or the actual played velocity of the trigger key can be used (trigger vel). For example, if a note's velocity is 80, scaling by 110% will increase the note's velocity to 88. This feature allows you to control the mix of the different parts in advance or "on-the-fly" as you play. If a part's velocity is set to 0%, that part will be removed from the mix.

Select Part

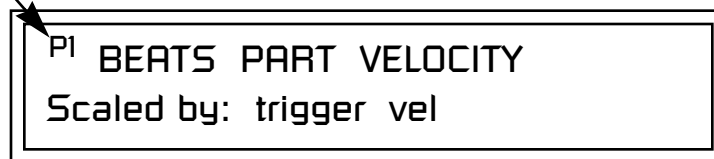

► To Set the Velocity for each Part:

1. Press the left cursor button to move the cursor under the Part field.
2. Select the Part number using the Data Entry Control. Parts 1-16 can be selected. (*All parts, shown as an "A", can be edited at once if "Edit All Layers" is enabled in the Master menu.*)
3. Move the cursor to the bottom line using the cursor keys and adjust the Velocity Scaling percentage using the Data Entry Control.
4. Repeat steps 1 through 3 for all the Parts you wish to adjust.
5. Press the Enter/Home button or use the cursor keys to move the cursor back to the screen heading.

Beats Part Transpose

Each Part of a Beat Riff can be transposed up to 36 semitones up or down. Transpose works by shifting the keyboard position and not by changing the tuning of individual notes. Therefore, on a Beats preset (bts:), where different instruments are assigned to each key, **Transpose has the effect of changing the instrument used by a particular part.** On a preset where a single sound covers the entire keyboard, Transpose will actually transpose the sound.

Select Part



► To set the Transposition for each Part:

1. Press the left cursor button to move the cursor under the Part field.
2. Select the Part number using the Data Entry Control. Parts 1-16 can be selected. (All parts, shown as an "A", can be edited at once if "Edit All Layers" is enabled in the Master menu.)
3. Move the cursor to the bottom line using the cursor keys and adjust the Transposition in semitones using the Data Entry Control.
4. Repeat steps 1 through 3 for all the Parts you wish to adjust.
5. Press the Enter/Home button or use the cursor keys to move the cursor back to the screen heading.

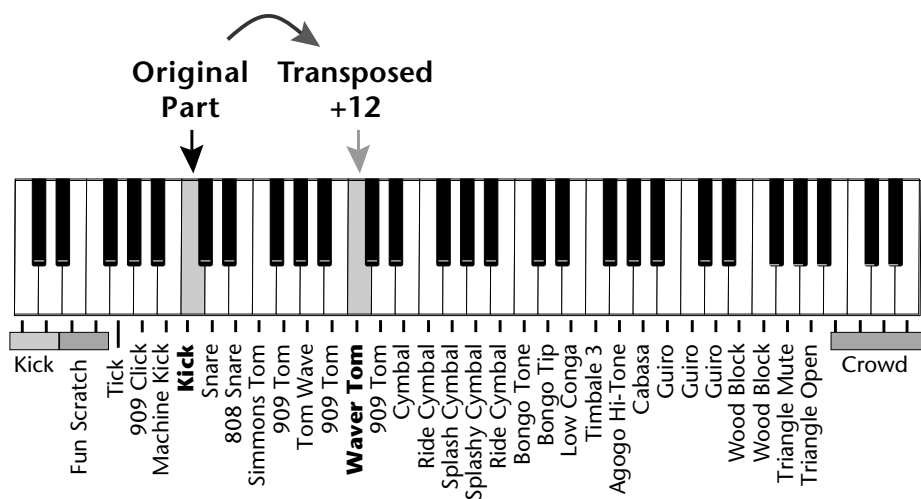

Beats Part Group

This screen is where you assign Parts to one of the four Groups. By grouping, you can play multiple parts with a single key. A part can be in one and only one group, or in no groups.

Select Part

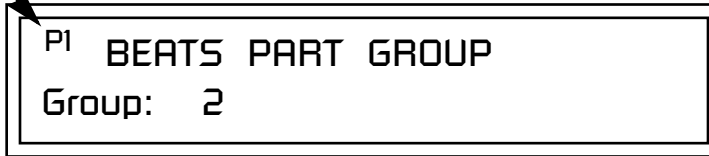

All Parts assigned to a Group will stop playing when the Group key is triggered, then untriggered even if the individual Parts in the Group are latched.

► To Assign a Part to a Group:

1. Press the left cursor button to move the cursor under the Part field.
2. Select the Part number using the Data Entry Control. Parts 1-16 can be selected. (All parts, shown as an "A", can be edited at once if "Edit All Layers" is enabled in the Master menu.)
3. Move the cursor to the bottom line using the cursor keys and select the Group (1-4 or none) using the Data Entry Control.
4. Repeat steps 1 through 3 for all the Parts you wish to assign.
5. Press the Enter/Home button or use the cursor keys to move the cursor back to the screen heading.

Master Riff

The Master Riff is selected from this screen. The Master Riff is used when Master (M) is selected for Beats in Beats mode enable screen.



► To Assign the Master Riff:

1. Use the cursor buttons to move the cursor to the lower line of the display.
2. Select the desired Riff using the Data Entry Control. (Beats Riffs are identified by the **bts:** prefix.)
3. If there is more than one ROM in your unit you can select Riffs from any ROM set. Move the cursor under the ROM ID and select using the Data Entry Control.
4. Press the Enter/Home button or use the cursor keys to move the cursor back to the screen heading.

Riff Tempo

This setting determines whether **Riff Tempo** (the tempo stored with each Riff) or the **Current Tempo** (the Base Tempo from the Master Clock) will be used for Beats.

To control the Riff Tempo from MIDI clock, set Riff Tempo to “use current tempo” and Base Tempo to “use MIDI”.



RIFF TEMPO
use riff tempo

► To Set the Riff Tempo Mode:

1. Use the cursor buttons to move the cursor to the lower line of the display.
2. Select “use riff tempo” or “use current tempo” using the Data Entry Control.
3. Press the Enter/Home button or use the cursor keys to move the cursor back to the screen heading.

Riff Controllers

Riffs contain real-time control information. This function allows you to turn these controllers On or Off for the Riffs. This control affects Audition Riffs as well as Beats Riffs.



RIFF CONTROLLERS
use riff controllers

► To Turn Riff Controllers On or Off:

1. Use the cursor buttons to move the cursor to the lower line of the display.
2. Select “use riff controllers” or “ignore riff controllers” using the Data Entry Control.
3. Press the Enter/Home button or use the cursor keys to move the cursor back to the screen heading.

Paste Repeat

The clipboard contents can now be pasted into another track or pattern from 1 to 99 times. The length of the clipboard is determined by the length of the last cut or copy. This new feature makes it easy to extend a section of a Song or Pattern.

The Paste operation *Merges* the clipboard data with the data on the destination track. It adds the new information to the existing data with the start of the data in the clipboard placed at the selected bar position.

Because of the data merging feature, the Paste operation can be used to “bounce down” multiple tracks to a single multichannel track.

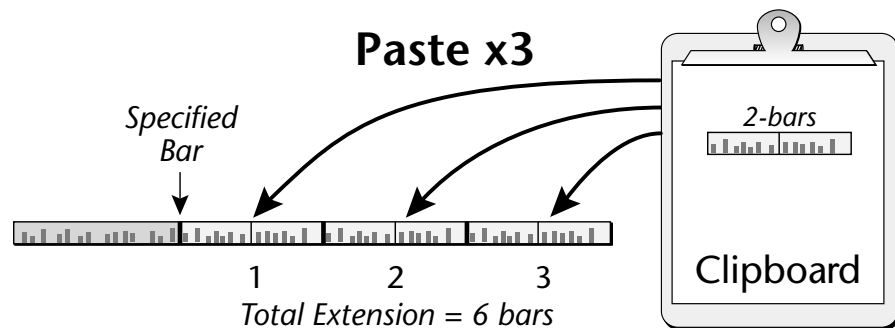

 Tracks can be freely cut, copied or pasted between songs and patterns.

► To Paste the Clipboard into a Track:

1. Press the **Pattern Edit** or **Song** button.
2. **Cut** or **Copy** data to the clipboard.
3. Scroll to the **Paste Clipboard to Track** screen shown below using the data entry control.

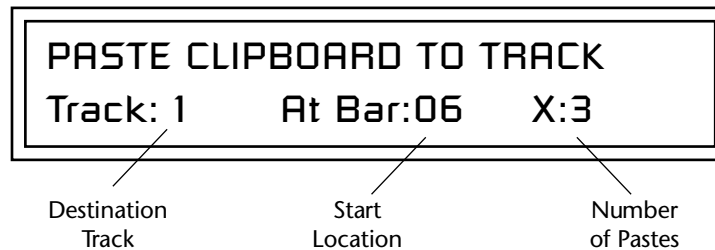

4. **Select the track** where you want the clipboard data to be pasted. The Home/Enter LED will be flashing once the cursor is moved to the lower line of the display.
5. **Select the bar** where the clipboard contents will be pasted.
6. **Select the number of times** you want the clipboard data pasted.
7. Press **Enter** to paste the data. Press any other menu button to **Cancel** the operation.

 You will not hear the results of the Paste operation until the sequence cycles around. (Hint: Press RTZ)

Erase Track

An entire track or a section of a track can be erased in a single operation. This feature makes it easy to erase a flubbed take or erase a section of track before pasting new data.

Erase Pattern or Song Track

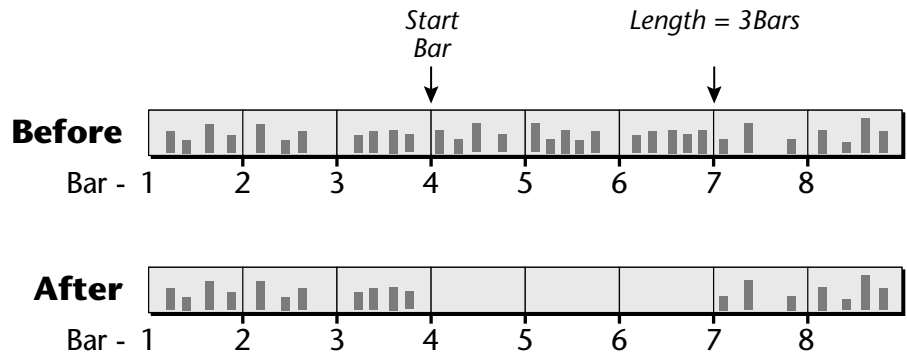

► To Erase a Track:

1. Press the **Pattern Edit** or **Song Edit** button.
2. Scroll to the **Erase Track** screen shown below using the data entry control.

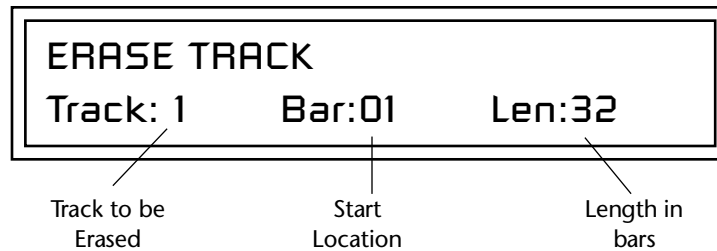

3. **Select the track** you want to erase. The Home/Enter LED will be flashing once the cursor is moved to the lower line of the display.
4. **Select the first Bar** you want to erase. The bar range for patterns is 01-32; the bar range for songs is 001-999.
5. **Select the Length** of the track you want erased.
6. Press **Enter** to erase the selected section of the Track.
7. Press **Enter** again to confirm the operation.
8. Press any other menu button or exit the edit menu to **Cancel** the operation.

Erase All Controllers

You can now erase **All Controller** events from a song or pattern. Erase “All Controllers” erases all continuous controllers, but not other controllers such as Pitch Bend, Aftertouch, etc.

The following types of events can be erased:

- All Track Events
- Notes
- All Controllers
- Program Changes
- SysEx Data
- Meter
- Tempo
- Poly Aftertouch
- Channel Aftertouch
- Pitch Wheel (Touchstrip)
- Any Continuous Controller (1-119) <- *This range has been expanded!*

Rechannelize Input

This new screen has been added to the MIDI menu. This feature makes it easier to record to the internal sequencer using an external keyboard. **Rechannelize Input changes the channel and destination of incoming MIDI data according to the settings in the Channel Assignment screen.**

To record multiple tracks, you simply change the track number and preset. You don't have to change the channel number of your external MIDI controller.

Rechannelize Input can be set to **Off**, **Always** or **On Record**. When set to **On Record**, the input will only be rechannelized when the Record LED is illuminated (Record or Record-Pause mode). This allows normal MIDI channel routing except when recording, when the channel data will be changed to match the current track.

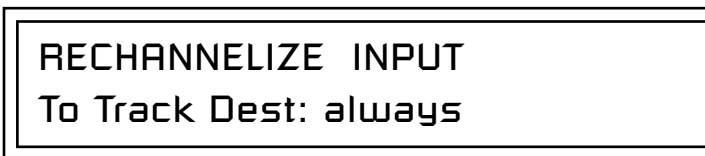

► Using Rechannelize Input to Record from a MIDI Keyboard:

1. Select an empty pattern.
2. Set Rechannelize Input to **Always**.
3. **Select a preset for Channel 1 (C01A)** from the Preset View screen. (Note that your MIDI keyboard always plays the preset assigned to the channel shown in the display.)

4. Turn Preset View Off to show the pattern screen again.
5. Press Record, then set the Pattern Length, Quantize & Metronome.
6. Press Play to begin recording.
7. Press Stop when finished. (Press Stop twice to Return to Zero.)
8. Select a preset for Channel 2 (C02A) from the Preset View screen. Notice that the keyboard now plays the new preset.
9. Press Record, then Play to begin recording.
10. Continue to record tracks.

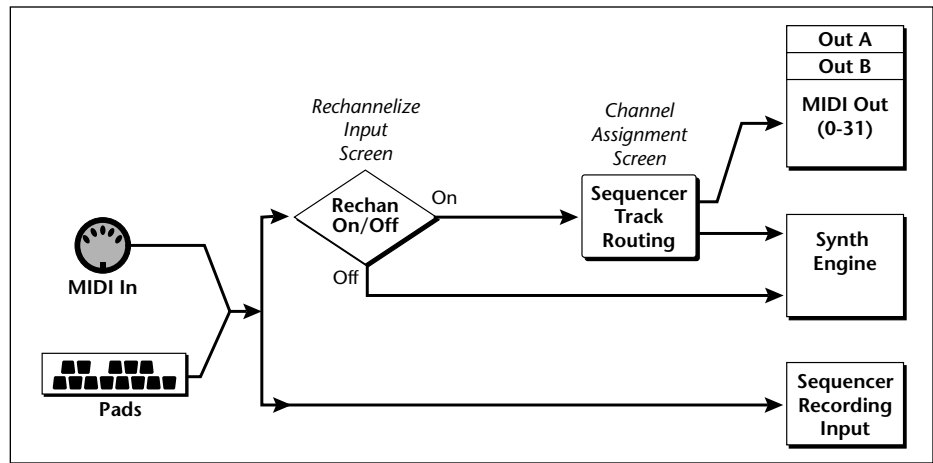

The Rechannelize Input feature routes performance data through the Sequencer Track Routing so that you don't have to change channels on your MIDI keyboard.

External Song Start/Stop

This is yet another new MIDI menu feature which lets the sequencer receive or ignore incoming MIDI Song Start (0xFA), Continue (0xFB), Stop (0xFC) and Song Position Pointer (0xF2) messages.

To use the instrument as a MIDI sound module with an external sequencer, set this control to "ignored." In this setting the internal sequencer won't start up every time your computer sequencer sends a start command.

If you're using an external MIDI controller to start and stop the internal sequencer, set this control to "accepted."

EXTERNAL SONG START/STOP
accepted

New Destination for Program. Knobs

In addition to being able to be sent out MIDI, to the internal synthesizer or both, the Programmable Knobs can now be routed to the sequencer for recording. This feature makes it easy to record any continuous controller to control the internal synth engine or external synthesizers. See the block diagram showing "Triggers & Programmable Knobs" on 26 for detailed information about the actual routing path.

```
K1 PROGRAMMABLE KNOBS
Ctrl: 1      Ch: Basic      seq
```

New Destination Field for Triggers

The Programmable Triggers now have a destination field. They can be individually programmed to the MIDI ports, sent to the internal synthesizer or both, or they can be routed to the sequencer for recording. The Triggers are no longer controlled by the "KEYBOARD TRANSMITS MIDI" screen. See the block diagram showing "Triggers & Programmable Knobs" on 26 for detailed information about the actual routing path.

```
T1 TRIGGERS   C3      Vel:64
Latch: off    Ch: Basic  seq
```

New Sequencer Features

Song Step Edit

When recording or editing in Song Step Edit mode, you must now press the **Enter** button to confirm each step change. Any changes you make without pressing Enter will be discarded. This feature protects against intentional edits. Everything works exactly the same except you must now press Enter when making changes such as Insert, Erase or Length changes. The Enter LED will be flashing to remind you. Use the +/- buttons to move back and forth through Song steps.

```
501 STEP   Ln: 04   Bar:001
0000 A2DJ
```



HOME/ENTER

Press the Enter button to confirm changes in Song Step Edit.

Automatic Channel Assignment

Whenever you change a channel, the sequencer now looks for a track that is assigned to that channel. Previously, channels were selected from tracks, but not vice-versa. This feature automatically selects the proper track in most cases, freeing you from having to think about it.



For your information, the algorithm works as follows:

1. If the current track is already assigned to this channel, or if this track is a "multi" track containing this channel (i.e. MultiA if channel was set to 07A) it does not change the current track.
2. If not, it starts at track 1 and looks for a track that is assigned to this exact channel, and sets it to the **first** track that is.
3. If there wasn't one, again it starts at track 1 and looks for a "multi" track that contains this channel, and sets it to the first track that does.
4. If none of the above succeed (meaning that this channel is not being played on any track), it does not change the current track.

Also, changing the track in the list editors or channel assignment screens sets the current track and vice versa.

Local Control Change Receive

Local Control on/off messages can now be received via MIDI or ignored. This feature was added because of the annoying behavior of some sequencers to automatically turn Local Control off.

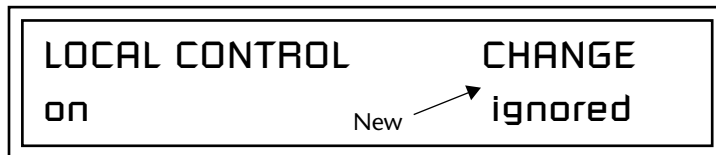

Tick 0 is now Visible for External tracks

When a track is set to "ext" (external transmit only), you will be allowed to see the coveted tick 0 spot for EVENTS. This allows you to remove any pre-sequence setup data (which is stored at Tick 0) left over from when the track may have been internal or both.

Connection Examples

Using the Internal Sequencer with an External MIDI Keyboard

The internal architecture has been changed in this software revision. These examples will help you with some common setups. When you have a working setup, it's a good idea to save and name the Multisetup to preserve your work.

In this setup, an external MIDI keyboard transmitting on a single MIDI channel is used to record into the internal sequencer. This demonstrates the new Rechannelize Input feature which frees you from changing the MIDI channel of your controller keyboard.

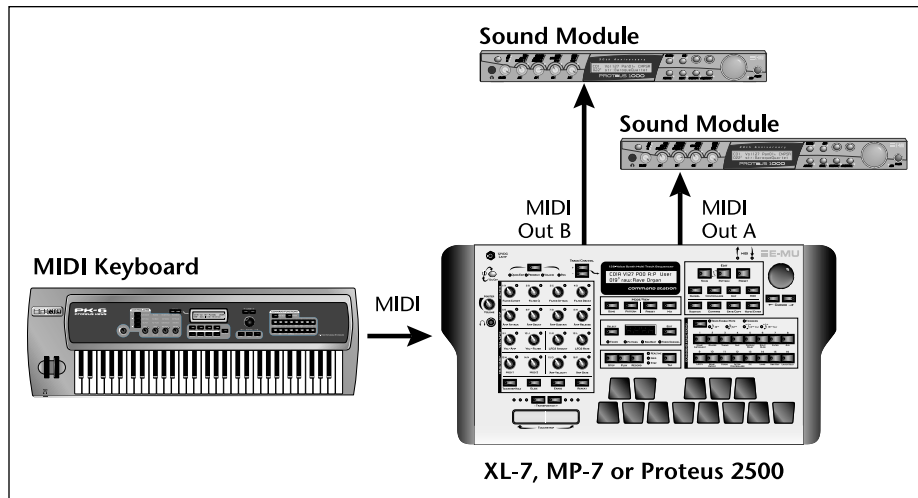

 If Channel Assign in the song/pattern edit menu is set to *external* or *both*, you'll get duplicate MIDI data if steps 2 & 3 in the setup are not set to Off.

► Setup the Following Controls:

1. RECHANNELIZE INPUT (MIDI) - **always**
2. KEYBOARD OUTPUTS MIDI (MIDI) - **don't transmit**
3. KNOBS OUTPUT MIDI (MIDI) - **don't transmit**
4. MERGE MIDI IN TO OUT (MIDI) - Out A: **off**, Out B: **off**
5. LOCAL CONTROL (Controllers) - **on**
6. **Save and Name the Multisetup.** (Global)

Optional Steps:

7. TRIGGERS (Controllers) - **Seq**
(If you want to record them into the sequencer.)
8. PROGRAMMABLE KNOBS (Controllers) - **Seq**
(If you want to record them into the sequencer.)

► **To Record a Sequence:**

1. Select an empty pattern or song.
2. Press **Preset View** and select a preset for your first track.
3. Press **Record**, then setup the Quantize, Metronome and Length parameters.
4. Press **Play** to begin recording. Recording begins after the count-in period (if any). If you're recording into a Pattern it will loop when it reaches the end of its length.

To Record another Track

5. Press the **Track** button to the left of the LCD to increment the track number.
6. Press **Preset View** and select a preset for the next track.
7. Press the **Stop** button twice to return to the beginning of the song or pattern.
8. Press **Record**, then **Play** to begin recording.
9. Repeat steps 5 through 8 to continue laying down tracks.

► **Optional: Recording Tracks to control an External Sound Module**

The diagram on page 20 shows two external sound modules connected. The channel assignment screen controls the routing of sequencer tracks to internal and external MIDI channels.

1. Set CHANNEL ASSIGN (*Song/Pattern Edit*) - Destination - ext



2. Set the MIDI channel as desired for the external sound module. Channels 01A-16A go to the "A" MIDI port; channels 01B-16B go to the "B" MIDI port.

Using an External Sequencer

In this setup, an external computer sequencer is used with the XL/MP/P2500 acting as a controller/sound module. As an optional connection, another sound module can be connected to the second MIDI Out of the XL/MP/P2500.

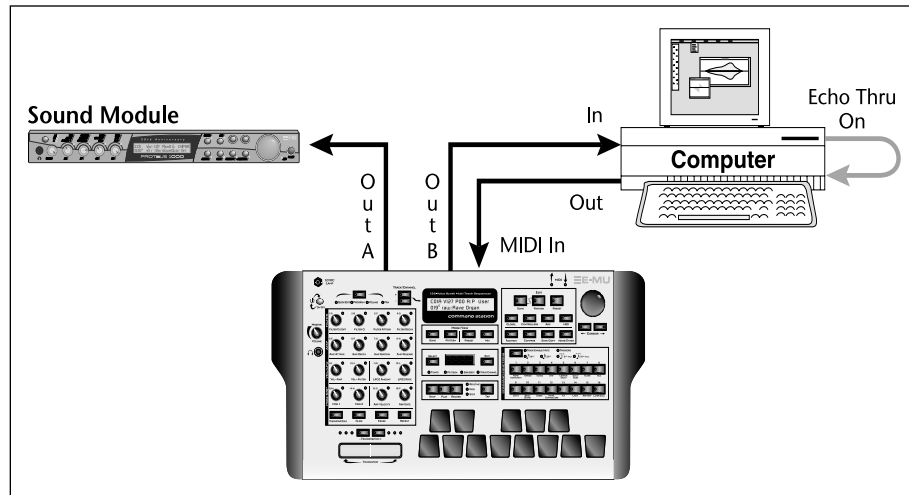

► Setup the Following Controls:

1. RECHANNELIZE INPUT (MIDI) - off
2. KEYBOARD OUTPUTS MIDI (MIDI) - transmit
3. KNOBS OUTPUT MIDI (MIDI) - transmit
4. EXTERNAL SONG START/STOP (MIDI) - ignored
5. MERGE MIDI IN TO OUT (MIDI) - Out B: off (Out A optional)
6. KEYBOARD CHANNEL (Controllers) - 01B
(Your sequencer will rechannelize to the proper MIDI channel.)
7. LOCAL CONTROL (Controllers) - off
8. Enable Echo Thru on your external sequencer.
9. TRIGGERS (Controllers) - ext
10. PROGRAMMABLE KNOBS (Controllers) - ext
11. Save the Multisetup. (Global)

Optional Steps:

12. BASE TEMPO (MIDI) - ext
(If you want to synchronize internal LFOs and clocks to the sequencer.)
13. MERGE MIDI IN TO OUT (MIDI) - Out A: on
(If Output A is connected to another MIDI sound module or device.)

Block Diagrams

Volume & Pan

Some of the biggest changes in this software version have to do with the internal signal routing and rechannelization.

These block diagrams show the internal signal routings and the functions of the various screens. They should prove highly useful when programming complex setups or for troubleshooting.

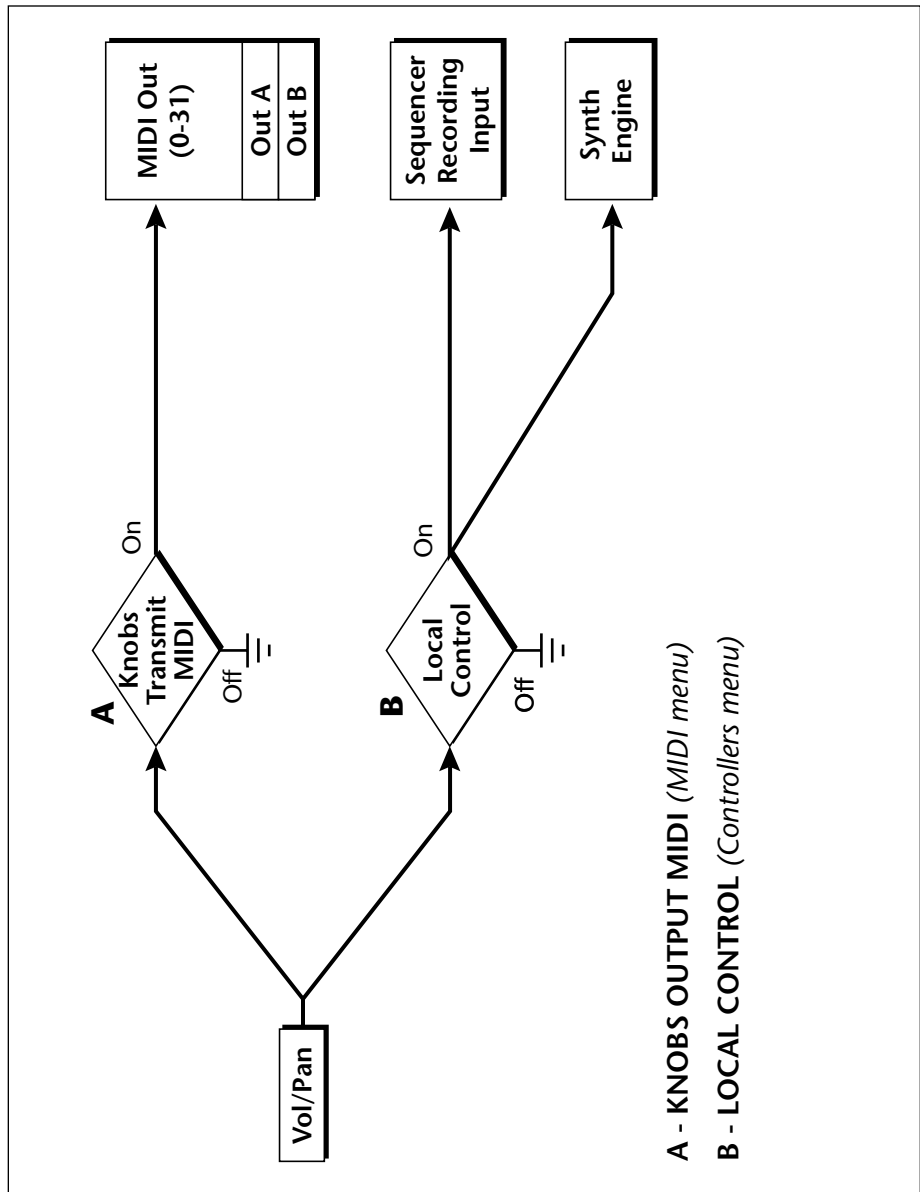

Block Diagrams

Pads Routing

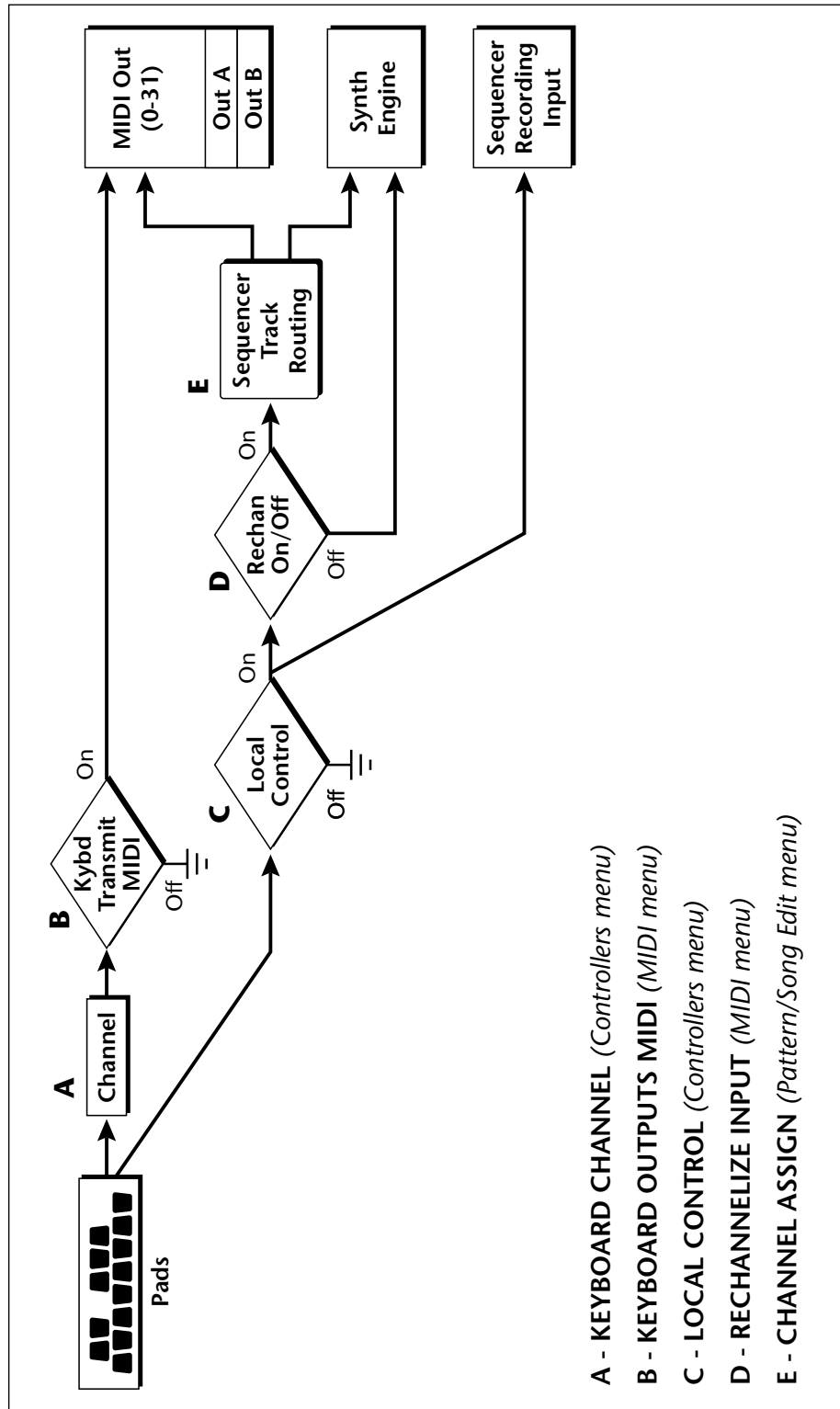

- A - KEYBOARD CHANNEL (Controllers menu)
- B - KEYBOARD OUTPUTS MIDI (MIDI menu)
- C - LOCAL CONTROL (Controllers menu)
- D - RECHANNELIZE INPUT (MIDI menu)
- E - CHANNEL ASSIGN (Pattern/Song Edit menu)

Block Diagrams

MIDI In



With Rechannelize On and if the track is "MultiA or MultiB", data is rechannelized to the Basic Channel.

To record multiple channels at the same time, turn Rechannelize Off.

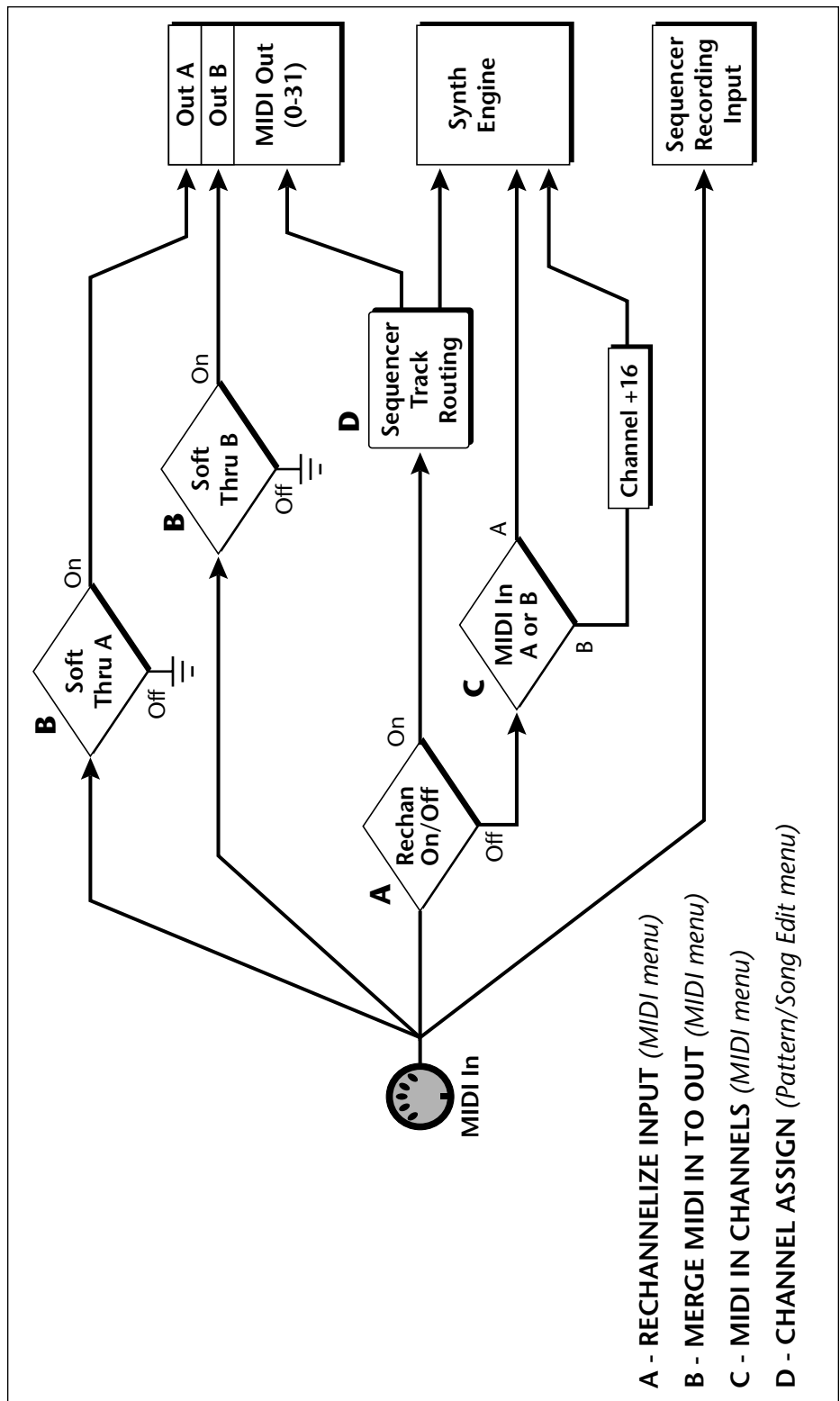

Block Diagrams

Triggers &
Programmable
Knobs

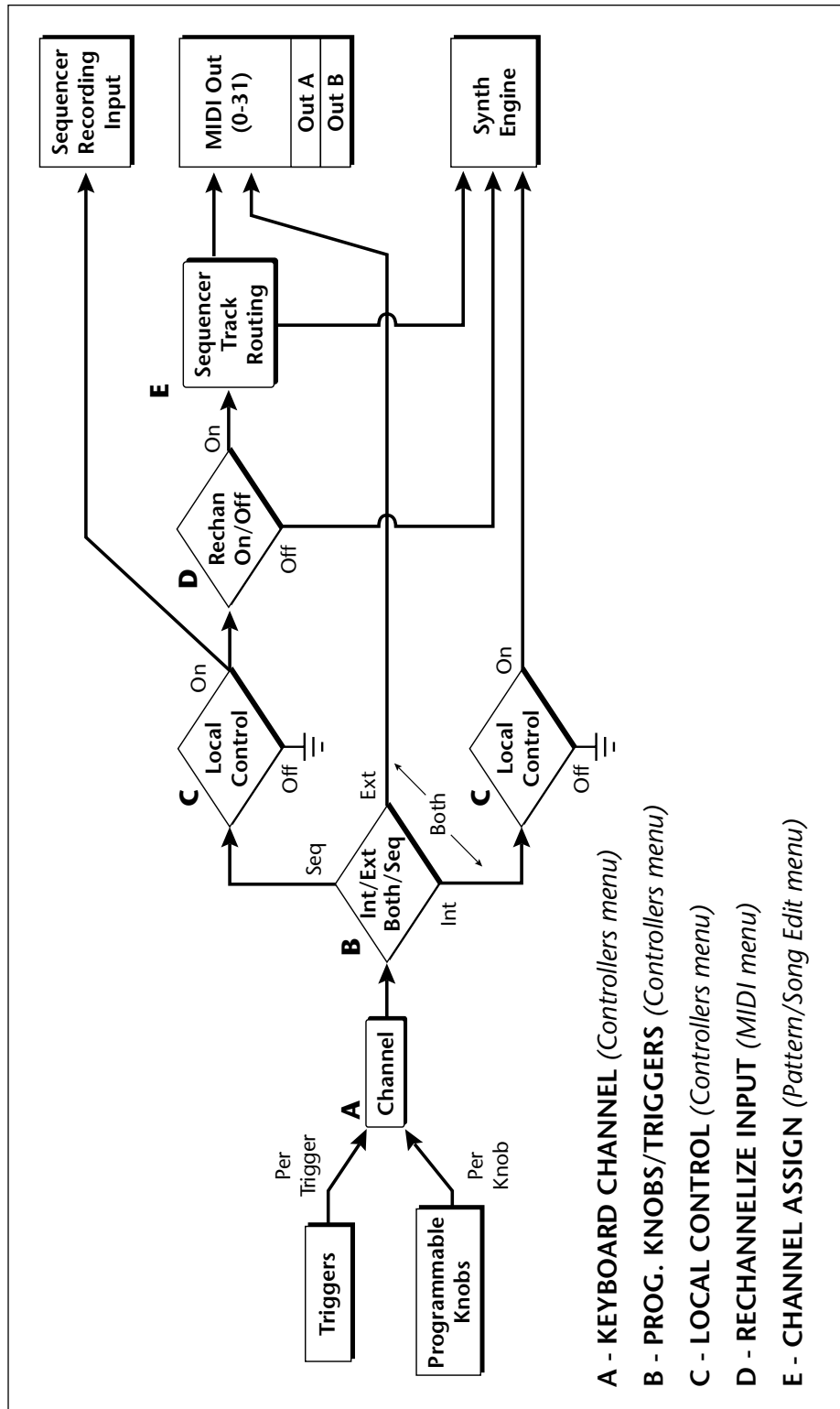

Block Diagrams

Quick Edit

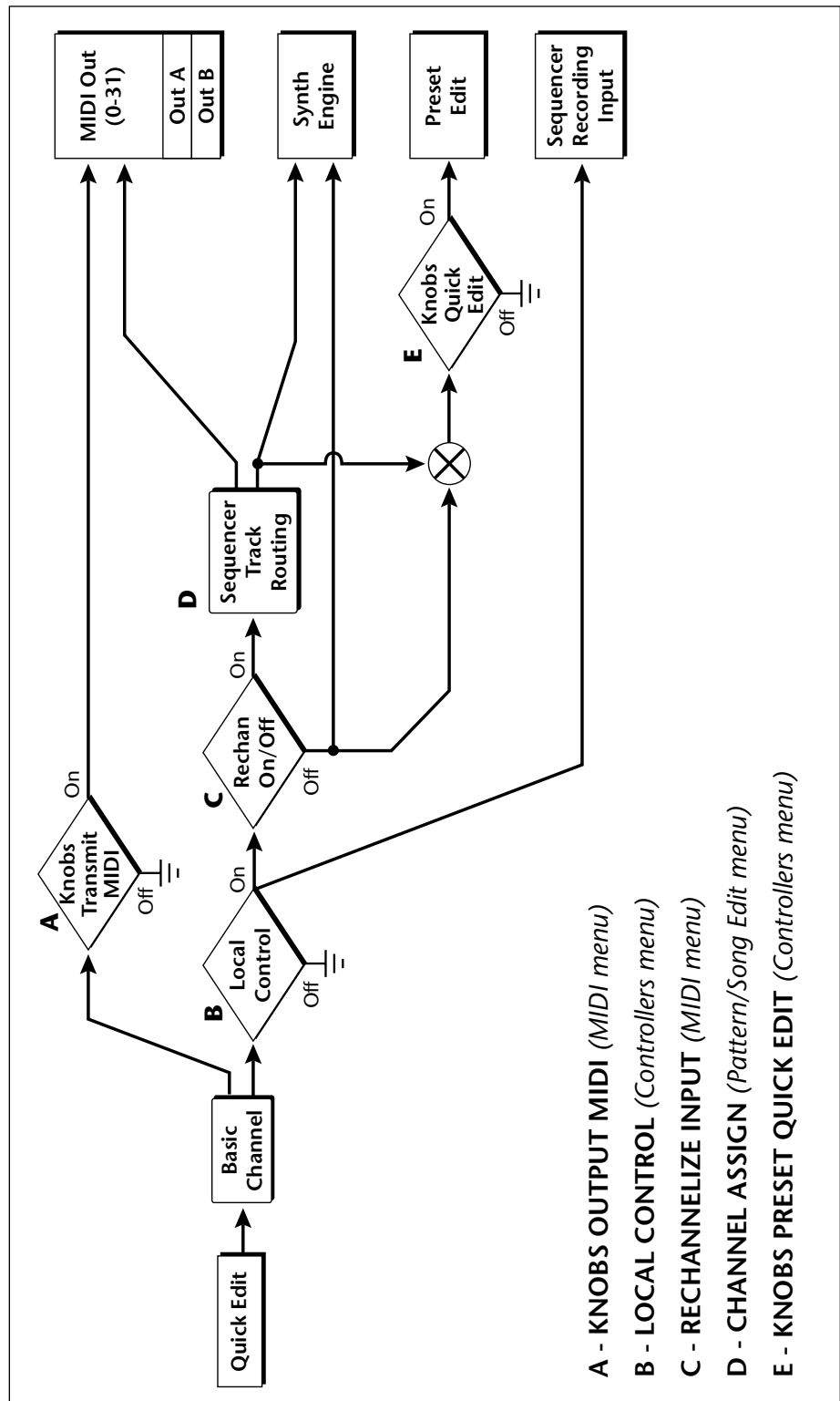



E-MU World Headquarters
E-MU / ENSONIQ
1600 Green Hills Road
Scotts Valley, CA USA
95067-0015
Telephone: 831-438-1921
Fax: 831-438-8612
Internet: www.emu.com

Europe, Africa, Middle East
E-MU / ENSONIQ
Suite 6, Adam Ferguson House
Eskmills Industrial Park
Musselburgh, East Lothian
Scotland, EH21 7PQ
Tel: +44 (0) 131-653-6556
Fax: +44 (0) 131-665-0473